

Golvo™ 9000 mobile lift



Instructions for Use

Golvo 9000

Prod. No. 2000045

Golvo 9000 LowBase

Prod. No. 2000049

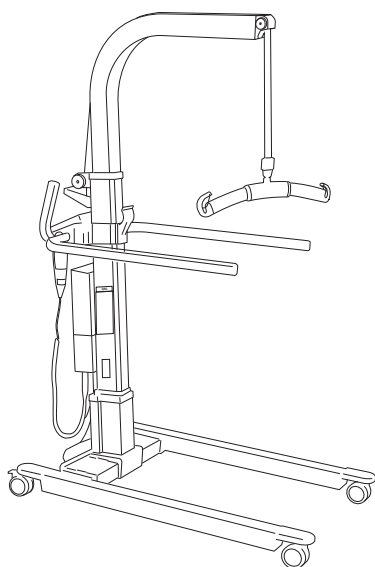

Golvo 9000

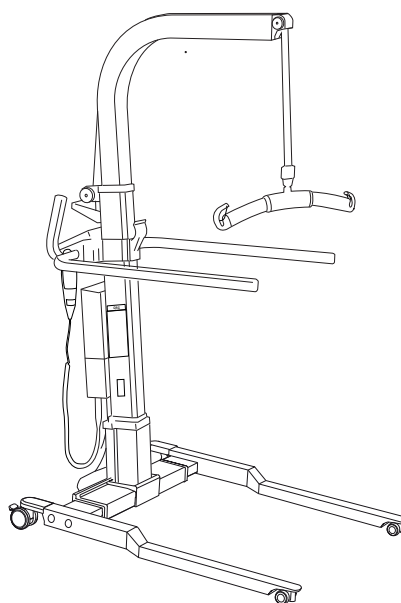

Golvo 9000 LowBase

Product Description

Golvo 9000 mobile lifts have a unique design, available in two models. Both models are an excellent aid for daily transfer of adults and children.

The LowBase model has extra low base for use in combination with bed frames or other equipment where space for the lift base is limited.

Individual fitting of Liko slings and other Liko lifting accessories to meet the patient need is of the utmost importance for optimal performance and safety when using the lift.

In this document, the person being lifted is referred to as the patient, and the person helping them is referred to as the caregiver.



IMPORTANT!















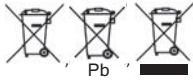

Lifting and transferring a patient always involves a certain level of risk. Read the instructions for use for both the patient lift and lifting accessories before use. It is important to completely understand the contents of the instructions for use. The equipment should only be used by trained personnel. Ensure that the lifting accessories are suitable for the lift used. Exercise care and caution during use. As a caregiver, you are always responsible for the patient's safety. You must be aware of the patient's ability to make it through the lifting situation. If something is unclear, contact the manufacturer or supplier.

Table of Contents

Symbol Description	3
Safety Instructions	4
Definitions	5
Technical Data	5
Dimensions.....	6
EMC Table.....	7
Assembly	9
Disassembly.....	12
Operation	12
Charging the Batteries	18
Maximum Load.....	19
Recommended Lifting Accessories	19
Recycling Instructions.....	21
Simple Troubleshooting.....	22
Cleaning and Disinfection	23
Inspection and Maintenance	25

Symbol Description

These symbols can be found in this document and/or on the product.

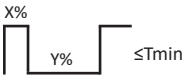
Symbol	Description
	For indoor use only.
	The product has extra protection against electric shock (Insulation Class II).
	Protection level against electric shock Type B.
	Warning; this situation requires extra care and attention.
	Read instructions for use before use.
	CE-mark.
IP N ₁ N ₂	Protection level against: ingress of solid objects (N1) and ingress of water (N2).
	Legal Manufacturer.
	Date of manufacture.
	Caution! consult instructions for use.
	Read instructions for use before use.
	Battery.
	All batteries in this product must be recycled separately. - Pb underneath the symbol indicate batteries containing lead - Single Black line underneath the symbol indicate this product have been placed on the market after 2005.
	UL Recognized Component Mark for Canada and the United States.
	EFUP, Environmental Friendly Usage Period (years).
	Environmentally-friendly product which can be recycled and reused.
	The Australian Safety/EMC.
	PSE Mark (Japan).
	Product Identifier.
	Serial Number.
	Medical Device.
	Recyclable.
	The safety and essential performance of medical electrical equipment.
	Proof of Product compliance to North American safety standards.
	Non-ionizing electromagnetic radiation.
	Duty cycle for non-continuous operation. The maximum active operation time X% of any given time unit, followed by a deactivation time, Y%. The active operation time shall not exceed the specified time in minutes, T.
 (01) 0100887761997127 (11) YYMMDD (21) 012345678910	GS1 Data Matrix Barcode that may contain following information (01) Global Trade Item Number (11) Production Date (21) Serial Number

Safety Instructions

Intended use

Transferring patients (adult or children) between devices (e.g., within the room), floor lifting, horizontal lifting, supporting patient limbs, ambulating patient, bathing patient, toileting patient, weighing patient and transferring patients from car. Intended for use in following environments: health care, intensive care, emergency ward, rehabilitation, habilitation.

This product is not intended to be used by the patient alone. Lifting and transferring a patient shall always be performed with the assistance of at least one caregiver. This product is used as a means to perform the lift but is not in contact with the patient; therefore we do not discuss or describe various patient conditions in this instruction for use. Contact your Hill-Rom representative for support and advice.

Certain environments and conditions can limit the correct use of the mobile lifts, including:

Thresholds, unlevel floor surfaces, various obstacles, and extra-thick carpets. These environments and conditions can cause the wheels of the mobile lift not to roll as intended, possible imbalance in the mobile lift, and increased exertion by the caregiver. If you are uncertain that your care environment fulfills the requirements for correct use of the mobile lift, please contact your Hill-Rom representative for further advice and assistance.

Unbalanced lifting poses a tipping risk and may damage the lift equipment!

Never leave a patient unattended during a lifting situation!

Before use, make sure that:

- the lift is assembled in accordance with the assembly instructions;
- the lifting accessories are properly attached to the lift;
- the battery has been charged for at least 6 hours;
- you have read the instructions for use for the lift and lifting accessories;
- personnel using the lift are informed of the correct operation and use of the lift.

Before lifting, always make sure that:

- the lifting accessory is selected appropriately, in terms of type, size, material and design, with regard to the patient's needs;
- the lifting accessories are not damaged;
- the lifting accessories are correctly attached to the lift;
- the lift strap is not twisted or worn and can move in and out of the lift;
- the lifting accessories hangs vertically and can move freely;
- the lifting accessory is correctly and safely applied to the patient in order to prevent injuries;
- the sling bar latches are intact. Missing or damaged latches must always be replaced with new ones;
- the sling's strap loops are correctly connected to the sling bar hooks when the sling straps are extended but before the patient is lifted from the underlying surface.

Incorrect attachment of sling to slingbar may cause severe injury to the patient.



Prod. No. 2000045 and 2000049 have been tested by an accredited testing institute

No modification of this product is allowed.

Use of this equipment adjacent to other equipment should be avoided because it could result in improper operation, if such use is necessary, observe and verify that other equipment are operating normally.

Particular care must be observed when using strong sources of potential disturbance, such as diathermy, etc, so that diathermy cables are not positioned on or near the lift. If you have questions, please consult the responsible assistive device technician or the supplier.

The lift may not be used in areas where flammable mixtures may occur, for example, in areas where flammable goods are stored.

This Caution notice is found on the Battery:

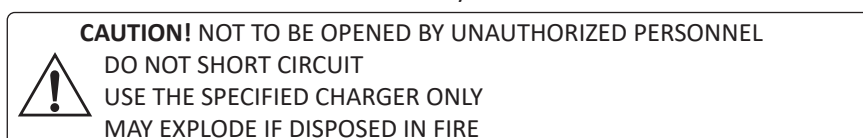

This Caution notice is found on the Control box:

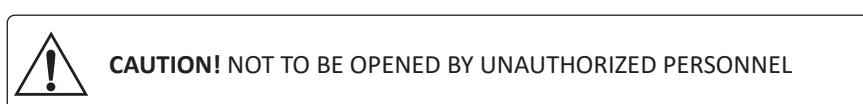

Definitions

1. Lift Strap
2. Sling bar with latches
3. Retractable armrests
4. Parking panel for sling bar
5. Optional; Quick reference guide
6. Optional: Holder for Quick Reference Guide
7. Product decal
8. Mast with inbuilt motor
9. Front wheels
10. Base
11. Rear wheels with brakes
12. Motor for base-width adjustment
13. Control box with;
Emergency stop
Electrical Emergency Lowering
Electrical Emergency lifting
Battery charger indicators
Information display
14. Battery
15. Hand control
16. Handles
17. Emergency Lowering (mechanical)
18. Lift arm
19. Extra low base (Golvo LowBase)

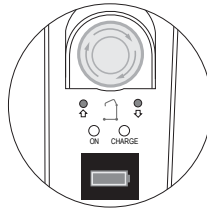

Golvo 9000

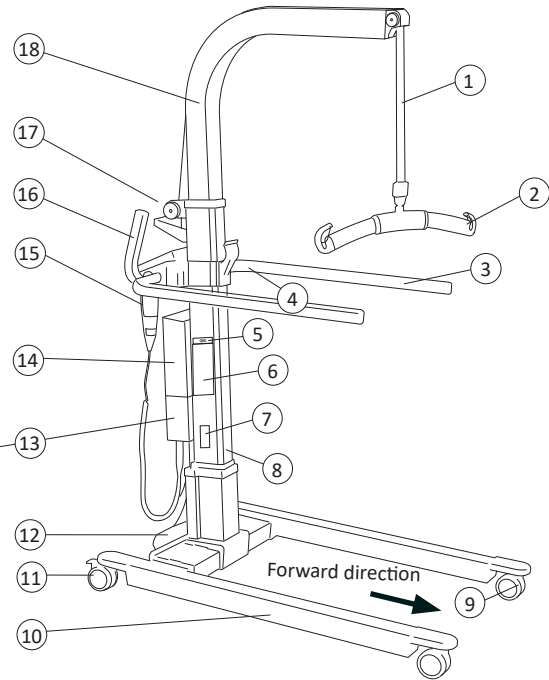

Golvo 9000 LowBase

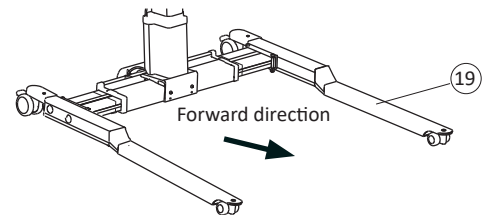

Technical Data

Maximum load: 200 kg (440 lbs)
Please note: The base width may be adjusted with weight up to 140 kg (308 lbs).

Material: Anodized aluminium

Weight: 9000: 38,8 kg (83,3 lbs)
9000 LowBase: 42,2 kg (93,0 lbs)
Heaviest removable part:
9000: 23,4 kg (51,6 lbs)
9000 LowBase: 23,4 kg (51,6 lbs)

Wheels: Front: 75 mm* (3 in) twin wheels.
*LowBase: 46 mm (1.8 in) twin wheels.
Rear: 75 mm (3 in) twin wheels with brakes.

Turning diameter Golvo 9000: 1330 mm (52 in)
Golvo 9000 LowBase: 1330 mm (52 in)

Emergency lowering device: Mechanical and electrical

Lifting Speed (no load) 37 mm/s (1.5 in/s) or
27 mm/s (1.1 In/s)

Lifting interval: 1245 mm (49 in) (height-adjustable)

Sound level: 52.8 dB(A)

Protection class: IP X4

Operating forces, controls: Hand control: 5 N

Electrical data: 24 V

Intermittent power: Int. Op 10/90, active operation max 2 min. Only 10% of a given length of time may be active, but no more than 2 min.

Battery options: Lead-acid gel, valve-regulated battery
24 V 2.9 Ah Prod. No. 2006106.
2,8 kg (6.2 lbs.)
Li-ION battery
25.6 V, 3.3 Ah Prod. No. 2006110.
1,4 kg (3.1 lbs.)
New batteries provided by supplier!

Battery charger: Internal charger, 100-240 V AC, 50-60 Hz, max 400 mA.

Lift motor: 24 V, 7.5 A

Base motor 24 V, 5.5 A

Surrounding functional environment: Temperature: +10°C to +40°C, (50° F to 104° F)
Humidity: 20% to 80% at 30°C non-condensing,
Atmospheric pressure: 700hPa to 1060hPa.



The device is intended for use indoors



Type B, in accordance with the electrical shock protection class.



Class II equipment.

Protected by Patent

Dimensions

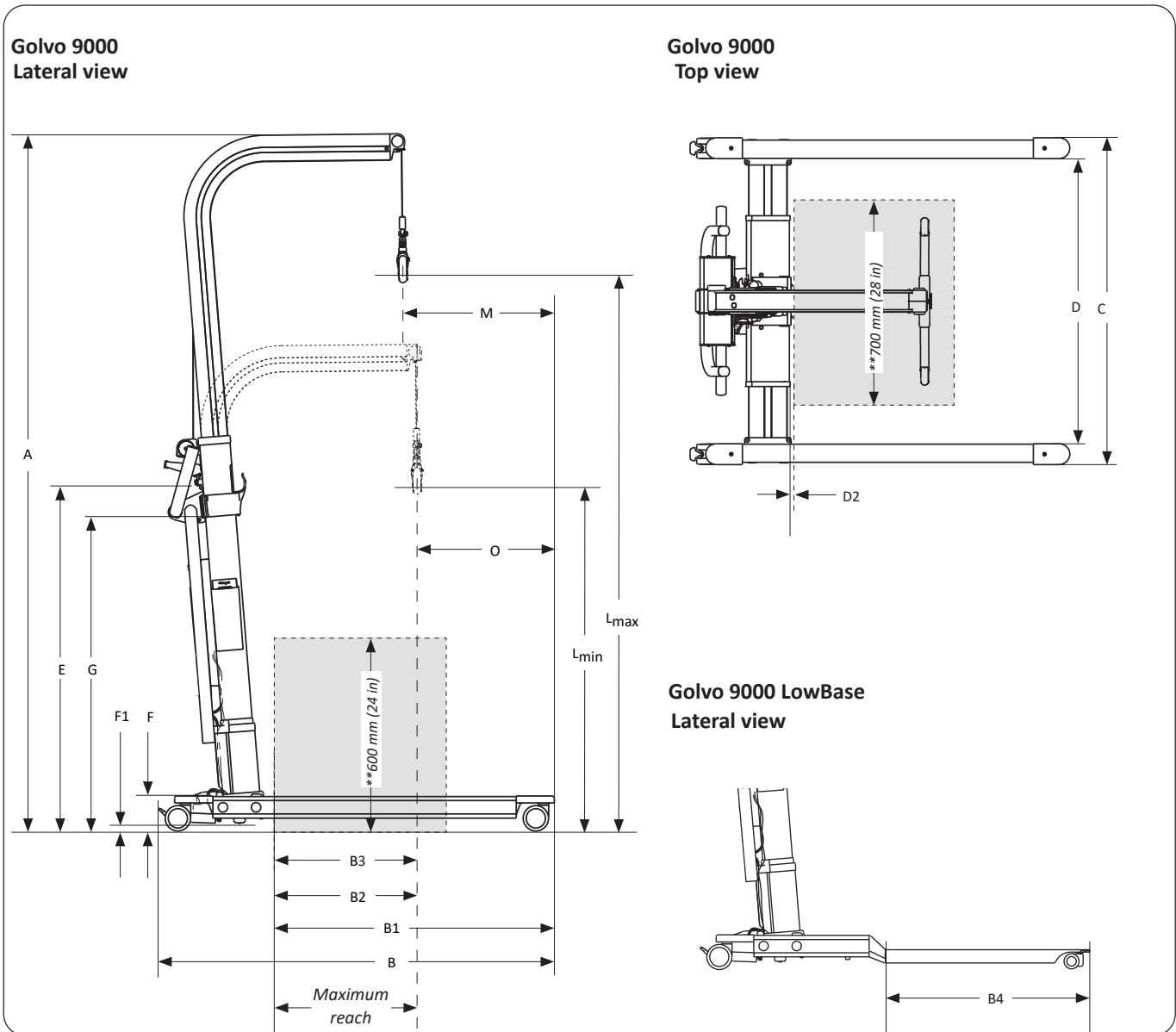

Measurements

Measurements in mm / in

Model	A		B	B1	B2	B3*	B4	C		D		D2*	E	F	F1	G	L _{max}	L _{min}	M	O
	max.	min.						max.	min.	max.	min.									
Golvo 9000	2090	1455	1185	870	480	480	-	1020	735	907	623	0	1100	105	25	940	1816	571	436	391
Golvo 9000 LowBase	2090	1455	1185	870	480	480	600	1028	745	907	623	0	1100	60 / 105	22	940	1816	571	436	391

Model	A		B	B1	B2	B3*	B4	C		D		D2*	E	F	F1	G	L _{max}	L _{min}	M	O
	max.	min.						max.	min.	max.	min.									
Golvo 9000	82.3	57.3	46.6	34.2	18.9	18.9	-	40.2	28.9	35.7	623	0	43.3	4.1	1.0	37	71.5	22.5	17.2	15.4
Golvo 9000 Low-Base	82.3	57.3	46.6	34.2	18.9	18.9	23.6	40.5	29.3	35.7	623	0	43.3	2.4 / 4.1	0.9	37	71.5	22.5	17.2	15.4

The lifting interval 1245 mm (49 in) is height-adjustable, see "Lift strap adjustment", Operation chapter.

Note: When changing to other lifting accessories check that the lift still achieves desired lifting height.

* Reference measurement according to Standard EN ISO 10535:2006

EMC Table

Guidance and manufacturer's declaration – electromagnetic emissions		
<p>The mobile lift is intended for use in the electromagnetic environment specified below. The customer or the user of the mobile lift should assure that it is used in such an environment. "Essential performance according to the manufacturer: The hoist shall not move unintentionally while being submitted to disturbances."</p>		
Emissions test	Compliance	Electromagnetic environment - guidance
RF emissions CISPR 11	Group 1	The mobile lift is suitable for use in all establishments including domestic establishments and those directly connected to the public low-voltage power supply network that supplies buildings used for domestic purposes.
RF emissions CISPR 11	Class B	
Harmonic emissions IEC 61000-3-2	Complies	
Voltage fluctuations/ flicker emissions IEC 61000-3-3	Complies	

Guidance and manufacturer's declaration – electromagnetic immunity			
<p>The mobile lift is intended for use in the electromagnetic environment specified below. The customer or the user of the mobile lift should assure that it is used in such an environment. "Essential performance according to the manufacturer: The hoist shall not move unintentionally while being submitted to disturbances."</p>			
Immunity test	IEC 60601 test level	Compliance level	Electromagnetic environment - guidance
Electrostatic discharge (ESD) IEC 61000-4-2	+/- 8 kV contact +/- 15 kV air	+/- 8 kV contact +/- 15 kV air	+/- 8 kV contact +/- 15 kV air Floors should be wood, concrete or ceramic tile. If floors are covered with synthetic material, the relative humidity should be at least 30 %.
Electrical fast transient / Burst IEC 61000-4-4	+/- 2 kV for power supply lines +/- 1 kV for input/output lines	+/- 2 kV for power supply lines n/a. for input/output lines	Mains power quality should be that of a typical commercial or hospital environment.
Surge IEC 61000-4-5	+/- 1 kV differential mode +/- 2 kV common mode	+/- 1 kV differential mode n/a. for common mode	Mains power quality should be that of a typical commercial or hospital environment.
Voltage dips, short interruptions and voltage variations on power supply input lines IEC 61000-4-11	0 % UT for 0,5 cycle, at 0, 45, 90, 135, 180, 225, 270 and 315 degrees 0 % UT for 1 cycle, at 0 degrees 70 % UT for 25 cycles at 50 Hz and 30 cycles at 60 Hz, at 0 degrees 0 % UT for 250 cycles at 50 Hz and 300 cycles at 60 Hz.	0 % UT for 0,5 cycle, at 0, 45, 90, 135, 180, 225, 270 and 315 degrees 0 % UT for 1 cycle, at 0 degrees 70 % UT for 25 cycles at 50 Hz and 30 cycles at 60 Hz, at 0 degrees 0 % UT for 250 cycles at 50 Hz and 300 cycles at 60 Hz.	Mains power quality should be that of a typical commercial or hospital environment. If the user of the [Equipment or System] requires continued operation during power mains interruptions, it is recommended that the [Equipment or System] be powered from an uninterruptible power supply or battery.
Power frequency (50/60 Hz) magnetic field IEC 61000-4-8	30 A/m	Complies	Power frequency magnetic fields should be at levels characteristic of a typical location in a typical commercial or hospital environment
<p>NOTE U_T is the a.c. mains voltage prior to application of the test level.</p>			

Guidance and manufacturer's declaration – electromagnetic immunity

The mobile lift is intended for use in the electromagnetic environment specified below. The customer or the user of the mobile lift should assure that it is used in such an environment.

"Essential performance according to the manufacturer: The hoist shall not move unintentionally while being submitted to disturbances."

Immunity test	IEC 60601 test level	Compliance level	Electromagnetic environment - guidance
Conducted RF IEC 61000-4-6	6 Vrms 150 kHz to 80 MHz	6 Vrms	Portable and mobile RF communications equipment should be used no closer to any part of the mobile lift, including cables, than the recommended separation distance calculated from the equation applicable to the frequency of the transmitter. Recommended separation distance $d = 1,2\sqrt{P}$ $d = 1,2\sqrt{P}$ 80 MHz to 800 MHz $d = 2,3\sqrt{P}$ 800 MHz to 2,7 GHz where P is the maximum output power rating of the transmitter in watts (W) according to the transmitter manufacturer and d is the recommended separation distance in meters (m). Field strengths from fixed RF transmitters, as determined by an electromagnetic site survey, ^a should be less than the compliance level in each frequency range. ^b Interference may occur in the vicinity of equipment marked with the following symbol. 
Radiated RF IEC 61000-4-3	10 V/m 80MHz to 2,7GHz	10 V/m	

NOTE 1 At 80MHz and 800MHz, the higher frequency range applies.

NOTE 2 These guidelines may not apply in all situations. Electromagnetic propagation is affected by absorption and reflected from structures, objects and people.

^a Field strengths from fixed transmitters, such as base stations for radio (cellular/cordless) telephones and land mobile radios, amateur radio, AM and FM radio broadcast and TV broadcast cannot be predicted theoretically with accuracy. To assess the electromagnetic environment due to fixed RF transmitters, an electromagnetic site survey should be considered. If the measured field strength in the location in which the Golvo™ 9000 lift is used exceeds the applicable RF compliance level above, the mobile lift should be observed to verify normal operation. If abnormal performance is observed, additional measures may be necessary, such as reorienting or relocating the mobile lift.

^b Over the frequency range 150 kHz to 80 MHz, field strengths should be less than 10 V/m.

Recommended separation distances between portable and mobile RF communications equipment and the mobile lift

The mobile lift is intended for use in an electromagnetic environment in which radiated RF disturbances are controlled. The customer or the user of the mobile lift can help prevent electromagnetic interference by maintaining a minimum distance between portable and mobile RF communications equipment (transmitters) and the mobile lift as recommended below, according to the maximum output power of the communications equipment.

Rated maximum output power of transmitter (W)	Separation distance according to frequency of transmitter (m)		
	150 kHz to 80 MHz	80 MHz to 800 MHz	800 MHz to 2.7 GHz
	$d = 1,2\sqrt{P}$	$d = 1,2\sqrt{P}$	$d = 2,3\sqrt{P}$
0.01	0,12	0,12	0,24
0.1	0,38	0,38	0,73
1	1,2	1,2	2,3
10	3,8	3,8	7,3
100	12	12	23

For transmitters rated at a maximum output power not listed above, the recommended separation distance d in meters (m) can be estimated using the equation applicable to the frequency of the transmitter, where P is the maximum output power rating of the transmitter in watts (W) according to the transmitter manufacturer.

Note 1: At 80 MHz and 800 MHz, the separation distance for the higher frequency range applies.

Note 2: These guidelines may not apply in all situations. Electromagnetic propagation is affected by absorption and reflection from structures, objects and people.

Assembly

Before assembly, make sure you have the following parts and tools:

- Lift mast with control box and hand control, sling bar with latches, 2 M6 screws
- Armrest
- Base, with width adjustment motor
- Battery
- Tools: 4, 5 mm hex keys
- Bag containing: charger cable, charger connector cable
- Instructions for use

⚠ Lock the wheels on the base before starting to assemble the lift.

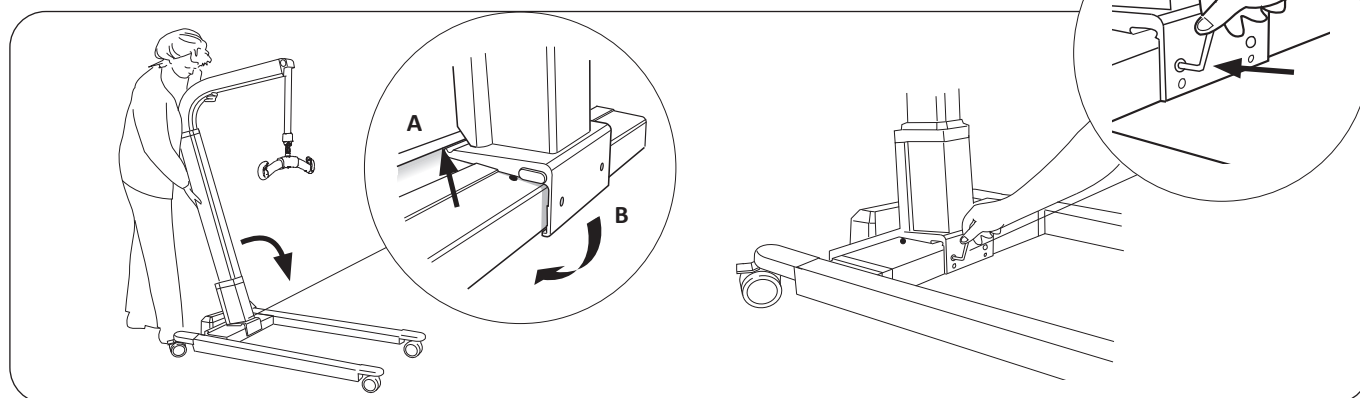

1. A) Position the lift mast between the two black plastic plugs on the base cross member.
B) Then push the mast forwards as in the figure above so that it hooks onto the cross member.

2. Screw the two provided M6 screws into the upper holes on the lift mast.

No screws in the lower holes!



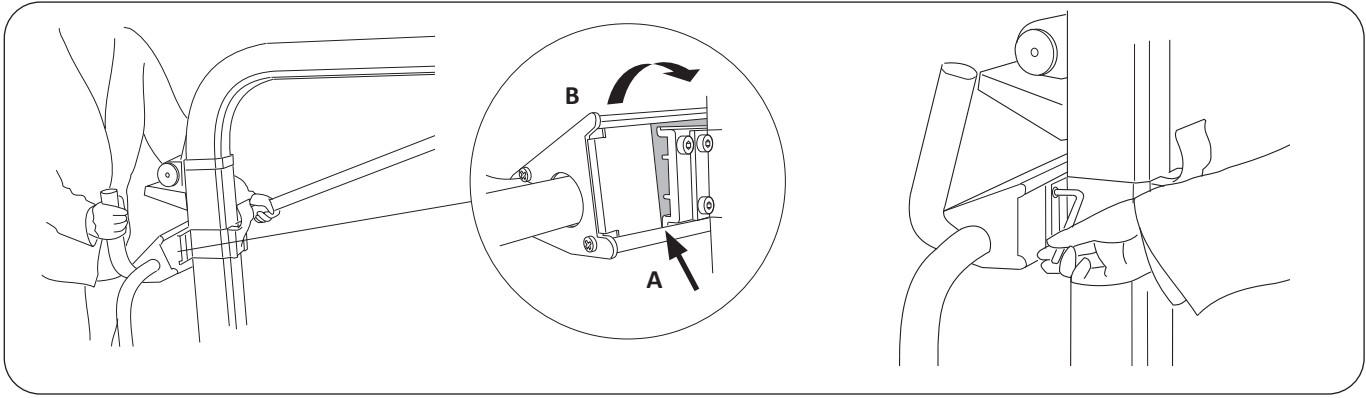

3. A) Place the armrest part in the attachment on the lift mast, starting with the lower groove.
 B) Lower and load the armrest until it hooks onto the upper groove on the armrest part. Do not remove any of the pre-assembled M8 screws completely, but it may be necessary to loosen them.
4. Secure the armrest by tightening the two pre-assembled M8 screws.

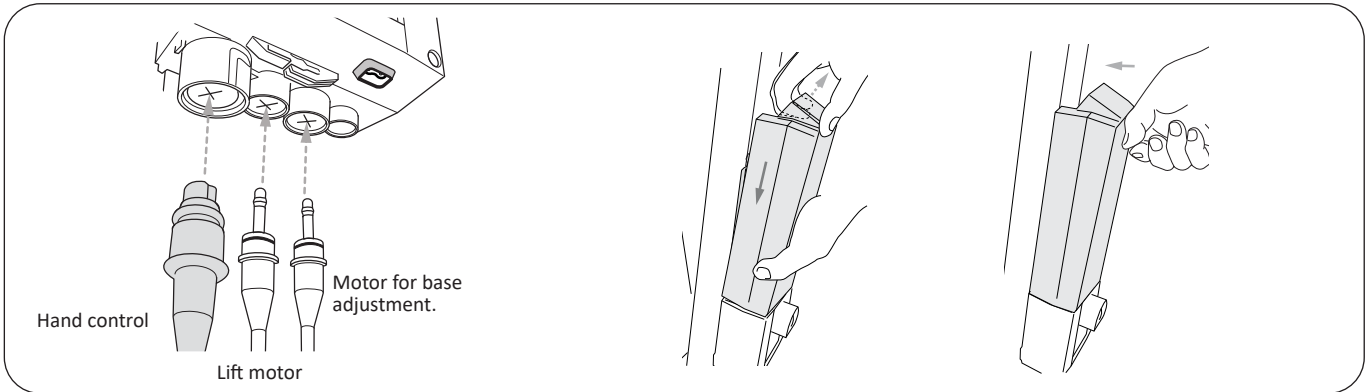

5. Connect cables to the control box, see illustration. Make sure plugs are fully seated.
6. Connect the battery and secure it to the control box bracket. A click sound can be heard when the battery is installed correctly.

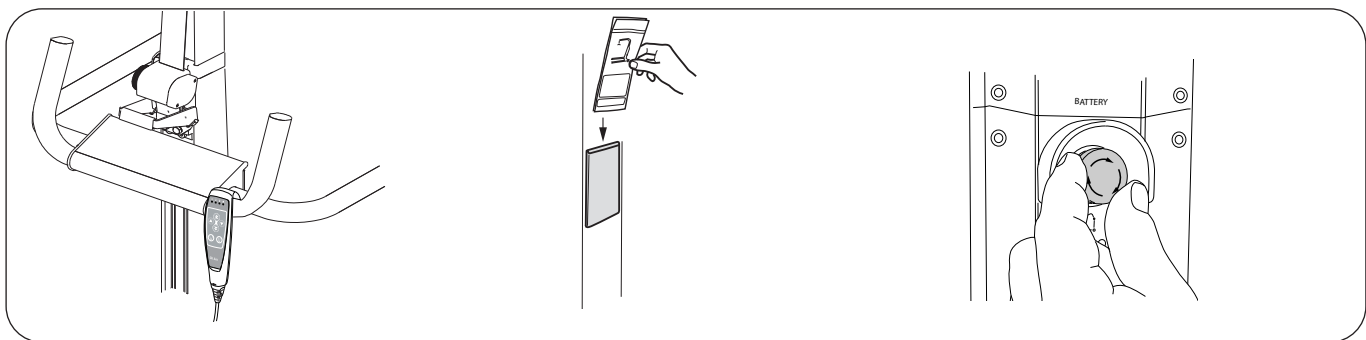

7. Hang the hand control on the handle.
8. Optional accessories: Quick reference guide to be placed in Holder for Quick reference guide on the mast.
9. Reset the emergency stop by turning the button clockwise.



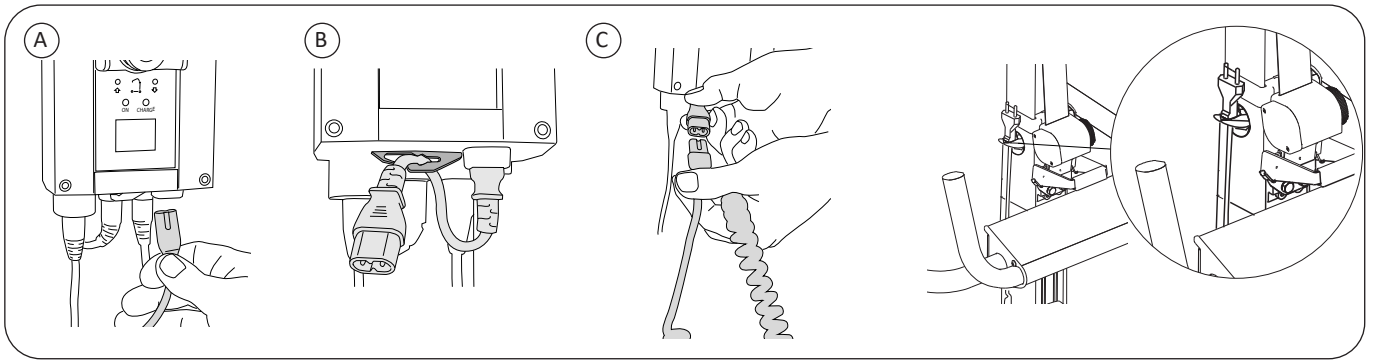



10. A) Connect the extension cable for the charging cable to the control box.
 B) Insert the extension cable in the tension clip underneath the control box.
 C) Connect the charging cable to the extension cable.

11. Place the charger cable on the hook provided on the mast after completed charging.

IMPORTANT! Always charge the battery before using the lift the first time. Charge the battery until charging is completed, see "Charging the Battery" for more information and instructions.

After assembly and charging, ensure that:

- The motion of the lift arm corresponds to the buttons on the hand control/operation panel.
- The emergency lowering functions are working (mechanical and electrical).
- The wheel brakes are working.
- The base-width adjustment works.
- The battery is fully charged.
- service interval is activated! Push following buttons on the handcontrol simultaneously:
 Up  / Down  , until a audio signal (single beep) is heard = service interval activated.
(Alternatively use the push buttons simultaneously for emergency lifting up and down on the control box)

Disassembly

1. Begin by removing the sling bar or other accessory that is fitted to the lift.
2. Remove the armrest holder as described below:

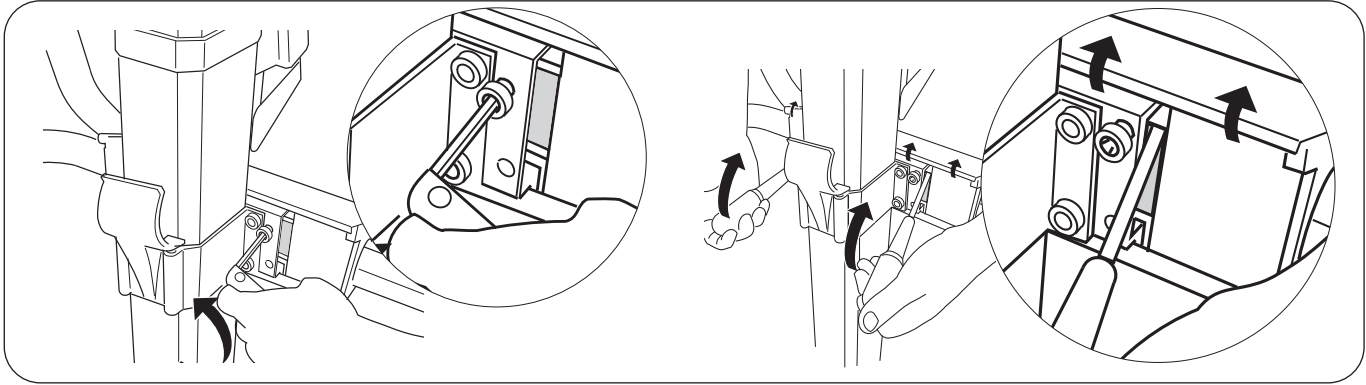

- A. Do not remove, just loosen the two M8 screws in the armrest holder on either side of the lift mast.
- B. Remove the armrest holder using two screwdrivers. Place screwdrivers inside on top of handlebar and pull up simultaneously as illustrated.

3. Loosen the cables from the control box, see assembly, Remove the mast as described below:

⚠ When the mast has been detached from the base, it must be supported to prevent it from falling.

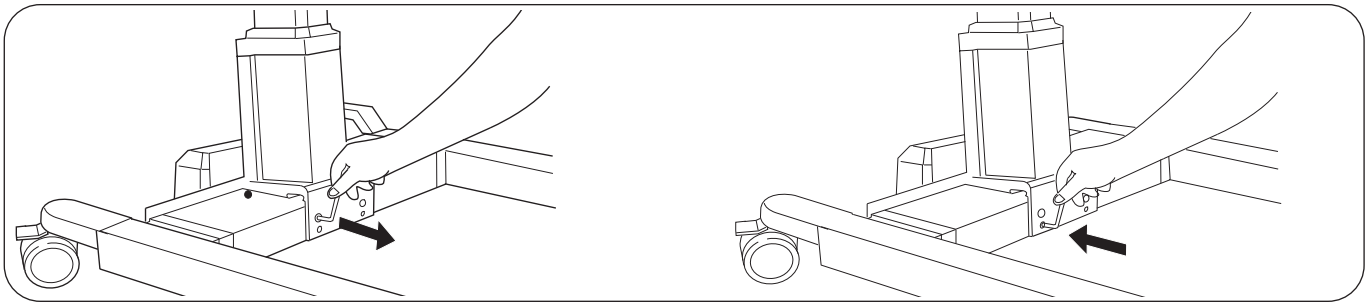

- A. Unscrew both the safety screws in the upper holes on the mast.
- B. Then screw the safety screws into the lower holes on the lift mast. This releases the mast from the base, and it can now be removed.

Operation

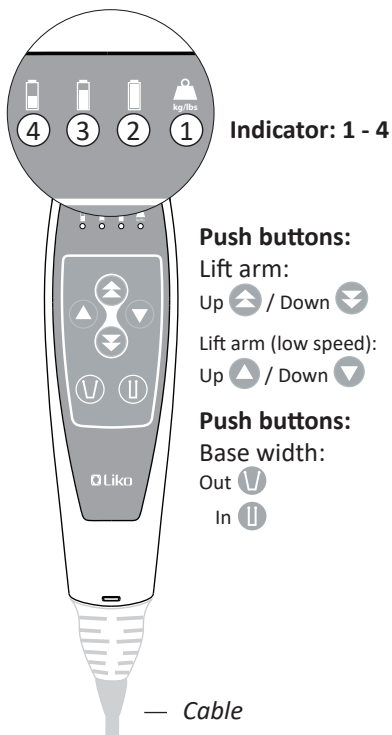

Handcontrol operation and indicators

Operate the lift using the push buttons on the handcontrol. For raising and lowering: Directional arrows show the direction of movement (up/down) The lifting and base movement stops as soon as the push button is released.

Indicator: 1 - 4

1 - Overload (Kg/lbs) light "flashes yellow", too much load is applied to the lift.

2 - Green light, battery power (100 - 50 %), Ok!

- will constantly light up green when charger is connected to mains.

3 - Yellow light, battery power (50 - 25 %), battery needs charging

4 - Yellow light, battery power (Less than 25 %), battery needs charging.

A buzzer will sound when pressing a push button.

Note! If the buzzer sound starts during an ongoing lift complete the lift and charge the lift afterwards!

4 - Light "flashes yellow" and a buzzer will sound when pressing a push button.

Charge the lift immediately! The remaining battery power can only make the lift arm go down.

Note! Please see chapter "Charging the Battery" for more information.

Control Box operation and information

- Emergency Stop button
 - Activate: Push the red button
 - Reset: Turn the red button clockwise.
- UP (Arrow), Electrical emergency lifting.
- DOWN (Arrow), Electrical emergency lowering.

Operation of the push buttons 2 and 3 are done by pressing with a narrow object into the circle mark above each (Arrow). The Actuator movement stops as soon as the push button is released.

- "ON" - lights up green when the charger is connected to mains.*
- "CHARGE" - lights up yellow constantly during charging and will turn off when charging is completed.
- Display Pop-up information:



Battery power (100 - 50 %) Ok!



Battery power (50 - 25 %) Battery needs charging.



Battery power (Less than 25 %) battery needs charging.

A buzzer will sound when pressing a push button.

Note! If the buzzer sound starts during an ongoing lift complete the lift and charge the lift afterwards!



Charge the lift immediately! A buzzer will sound when pressing a push button. The remaining battery power can only make the lift arm go down.



The lift is connected to the mains.



Short circuit warning!
check cables and connections.
Warning is shown until repaired!



Overload!
Too much load is applied to the lift.



Service needed; contact Hill-Rom.

6. Information display:

Activate information display by a "quick press" at a UP, push button.

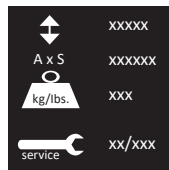

xxxxx

→ Total number of lift cycles with load

A x S

xxxxxxx

→ Work done by actuator; Amp. x Sec.

kg/lbs.

xxx

→ Number of overload indications

service

xx/xxx

→ Days since last service/Days between services.

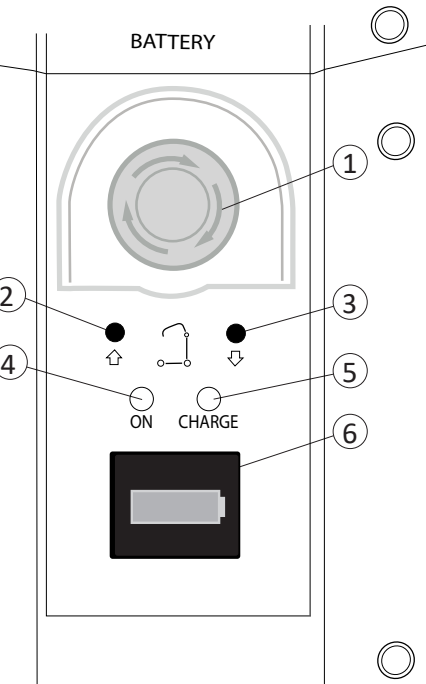

Li-ION battery - specific information

Sleep mode! the sleep mode will be activated in a Li-ION battery if not in use or charged in one week or more. The sleep mode switches off the battery and it's electronics to save power. The battery will stay in sleep mode until the battery is set back to operation mode again.

How to set the Li-ION battery back in operation mode; Charge the battery, when the "CHARGE" indicator, (5) is lit the battery has been set back in operation mode and ready for use. Note! We recommend to charge the battery until charging is completed, see "Charging the Battery" for more information and instructions.

Delay! a delay to indicators for current battery power at the control box and hand control occurs if the emergency stop function is activated and restored, see 1 above.



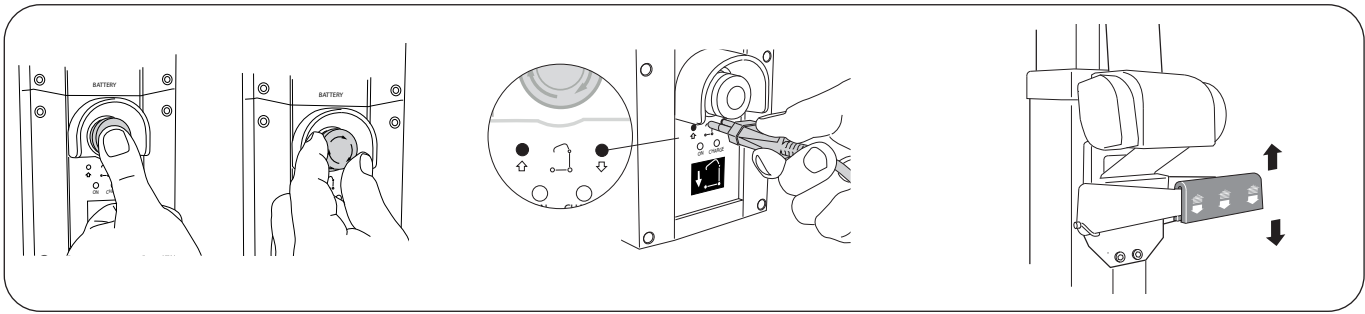

To activate the emergency stop:

Push the red Emergency Stop button on the control box.

To reset the emergency stop:

Turn the button clockwise.

Electrical emergency lowering / lifting

Use a narrow object to press into the circle mark above each (Arrow), See chapter "Operation" for more information.

Do not use sharp objects, since this may cause damage on the control box!

Mechanical Emergency Lowering

Emergency lower by moving the handle up and down. Repeat the motion until the patient being lifted is on a firm surface; draw down the sling bar manually and continue to pump the handle until the sling bar is low enough to enable the sling's strap loops to be unhooked.



Locking the Wheels

The rear wheels can be locked to prevent rotating and turning. The locking/unlocking of the wheels is done with the foot.

⚠ Locked wheels during lifting can increase the risk of tipping.

NOTE: When lifting, the wheels should be unlocked so that the lift can be moved to the patient's center of gravity. The wheels should be locked, however, if there is a risk of the lift rolling into the patient, for instance, when lifting from the floor.

Lift strap adjustment



After mechanical emergency lowering / Restoring the lifting level

If the lift strap has been lengthened due to using the emergency lowering function, the lift interval height will be lower than previously. To restore maximum lifting height, the lift strap must be reset to its original length.

Do as follows:

1. Remove any load / weight from the strap above the emergency lowering device. Do this by either placing the sling bar above the lift arm or by another person holding the sling bar up so that the strap hangs loose.
2. Lower and raise the handle with your left hand. At the same time tension the strap by turning the knob (a) clockwise with your right hand. Repeat this procedure until the red mark on the strap is just above the emergency lowering device.

Adjustment of the lift interval level

If it is necessary to reach a lower level with the sling bar, this can be arranged by lengthening the lift strap using the mechanical emergency lowering device. Do not lengthen the strap more than necessary as the highest obtainable lifting level is also affected.

An example of when it would be advantageous to lower the lift interval is when lifting from the floor using a sling whose strap loops do not reach up to the sling bar hooks when the lift is in its lowest position.

Do as follows:

Push down the red emergency lowering handle at the same time as loading the sling bar (pull down the sling bar with your other hand). This extends the strap and the sling bar is lowered. Repeat until the required strap length is obtained.

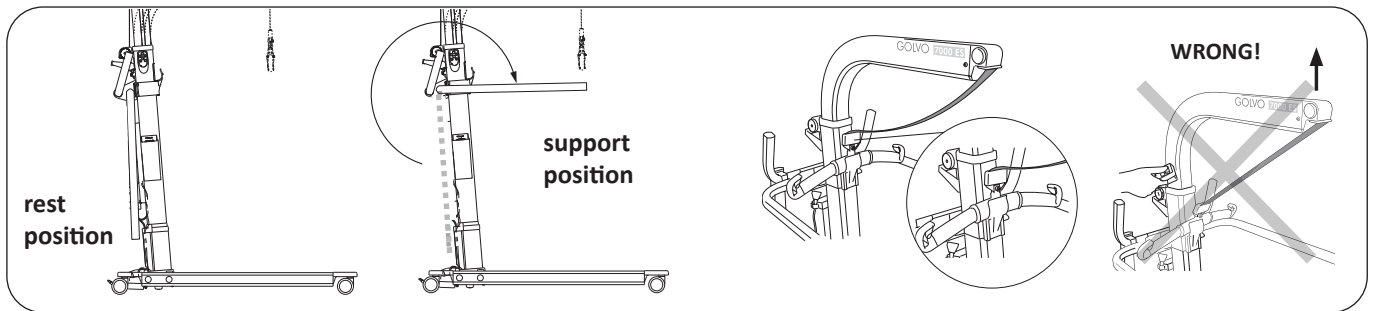

Armrest

To use the armrest you need to rotate it from the (vertical) rest position up to the (horizontal) support position. The armrest have two purposes: to help the patient feel more secure and facilitate for the caregiver when moving the lift.

⚠ When using the lift to transfer a patient between rooms, the armrest should be set in the support position!

Parking the sling bar

When the lift is not in use or is being moved without a load, it can be beneficial to place the sling bar in the parking panel.

The parking panel is intended for parking Universal SlingBars 350, 450 and 600 (all models).

⚠ When the sling bar is parked in the parking panel, the lift should not be raised since this could be dangerous and cause personnel injury or damage to the lift if the sling bar should release and swing out from the panel.

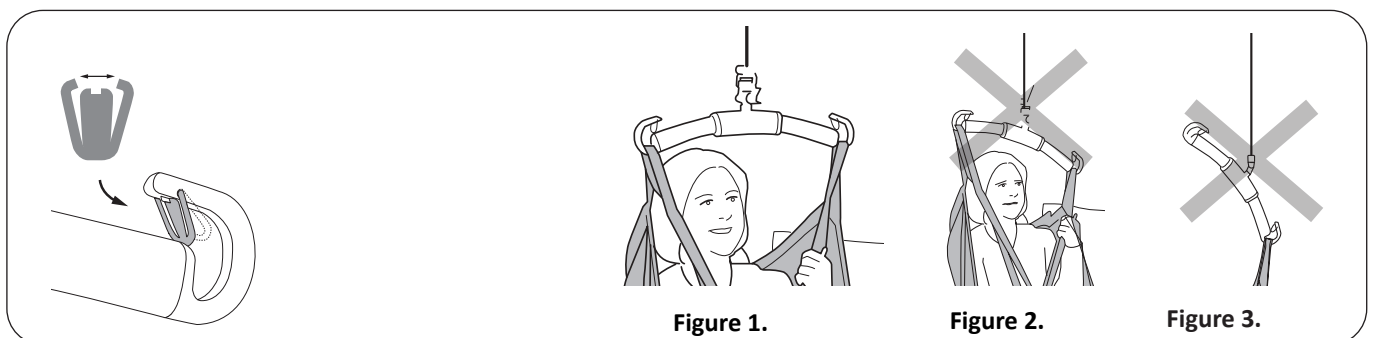

Installation of Latches

After installation, ensure that the spring loaded clip is taut against the sling bar and moves freely in the sling bar hook.

Lift correctly!

Before each lift, make sure that:

- the Sling loops at opposite sides of the Sling are at the same height
- all the Sling loops are fastened securely in to the Slingbar hooks
- the Slingbar is level during the lift, see Figure 1.

⚠ If Slingbar is not level (see Figure 2) or if the sling loops is wrongly attached to the Slingbar (see Figure 3) lower the user to a firm surface and adjust according to the Instruction for use of Sling in use.

⚠ An improper lift can be uncomfortable for the user and cause damage to the lift equipment! (see Figure 2 and figure 3).



Position of the Lift when Lifting

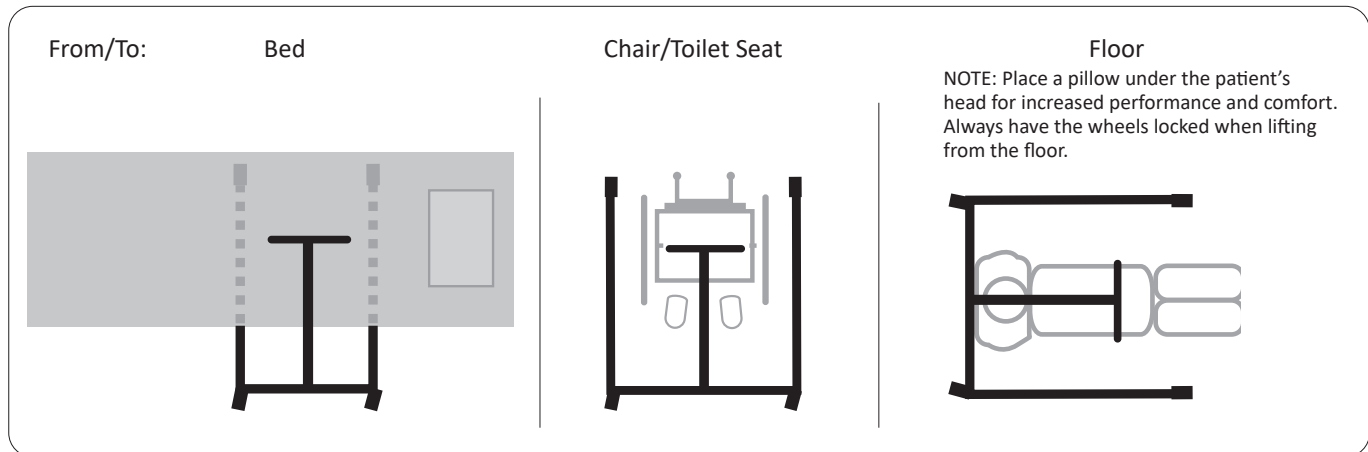

Transfer from car

Ensure that the lift used for car transfers is always stored and charged indoors. Outdoor operation should be kept to a minimum. Using the lift in harsh conditions such as rain, snow or extreme cold may impact the performance of the lift immediately.

Prerequisites

Transfer from car is applicable from the front and rear with the patient in a seated position. The caregiver must assess that transfer from the car is achievable. Considerations should be made regarding the status of the patient (status/condition, height and weight, position and accessibility), the relative size of the car and position of the lift equipment. The ground surface of the transfer area should be level, hard and smooth and free from gravel, debris, ice and potholes. Two caregivers are recommended for this task. A gurney or a wheel chair should be in the immediate vicinity of the car when performing the lift. Recommended slings for car transfer are the Universal Sling (models 000 & 002) and the High Back Sling (models 200/210/25/26). For correct sling application consult the sling instruction for use.

Do as follows:

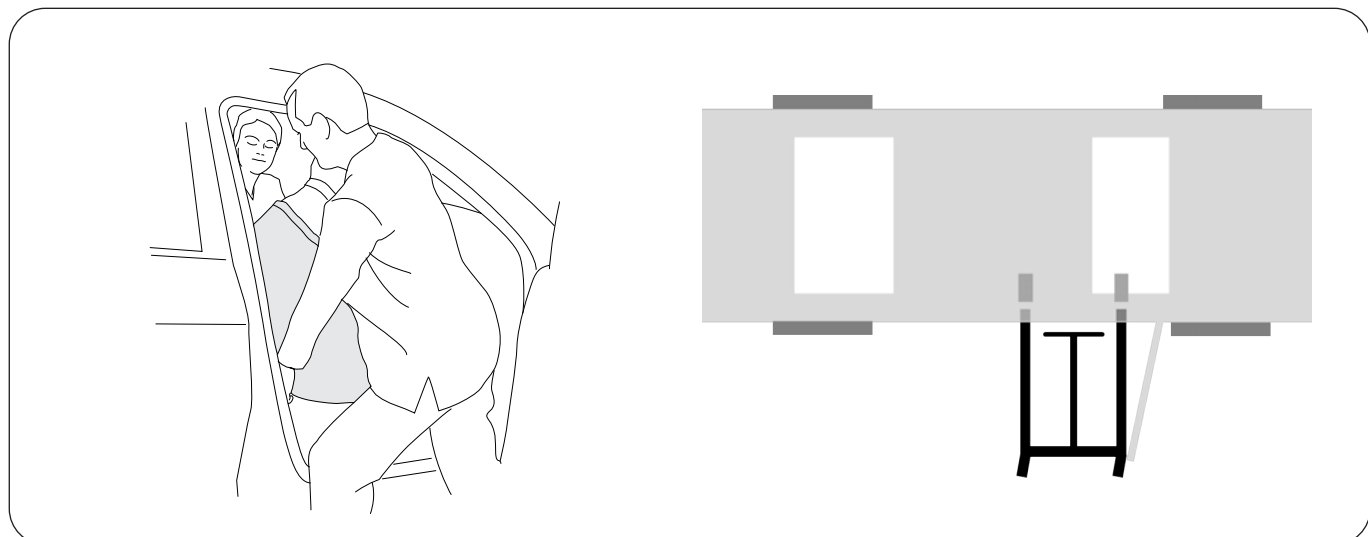

1. Apply the sling according to the sling instruction for use, a HandySheet or Tube can be used to reduce friction. One caregiver may assist from inside the car if necessary.

2. Position the lift as perpendicular as possible to the car, with the car door open. Keep the lift arm outside the car and the wheels of the lift unlocked.





3. Attach sling loops to the sling bar. Ensure the correct application of sling loops to the sling bar. Raise the lift to apply more tension on the sling. Rotate the patient toward the door opening and guide the legs of the patient out of the car. Apply friction reducing devices if necessary.

4a. One caregiver must guide the sling bar and patient out of the car and ensure that the head of the patient is guided safely while exiting the car. The other caregiver will need to raise the lift while simultaneously pulling the lift backwards.

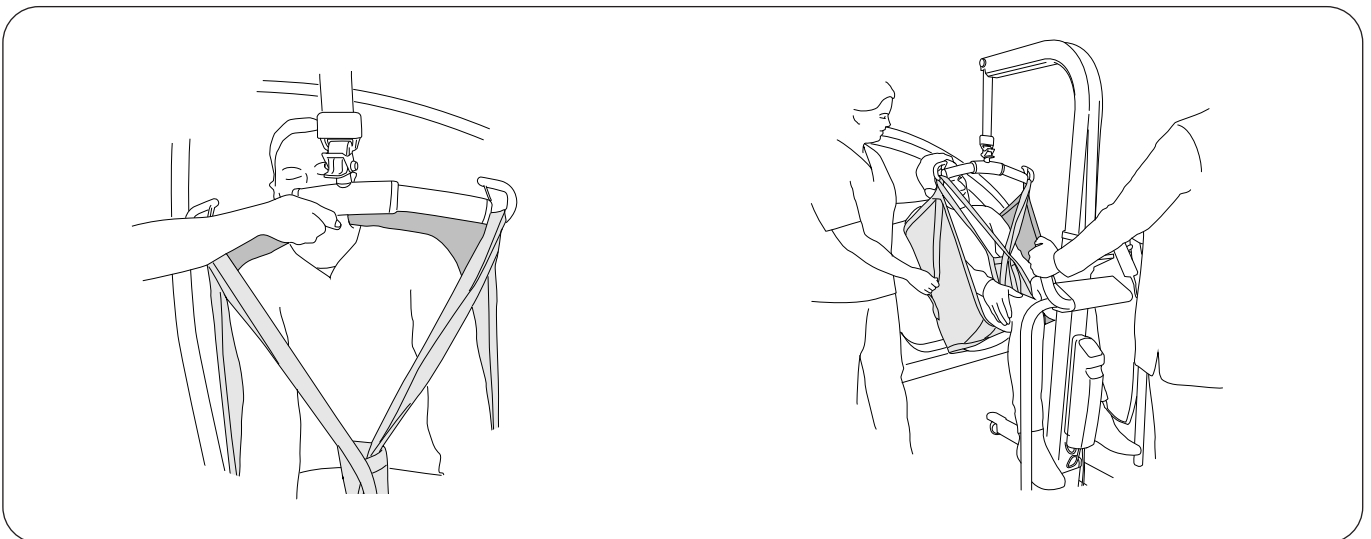

4b. Notice the correct grip on the sling bar to avoid pinch injuries to the caregiver as the sling bar is guided out of the car. Avoid placing hands between the sling bar and the door frame of the car.

5. Removal of the patient from the car is complete, continue the transfer to a wheel chair or gurney.

Charging the Battery

Charger information

1. "ON" - lights up green when the charger is connected to mains.
2. "CHARGE" - lights up yellow constantly during charging and will turn off when charging is completed.

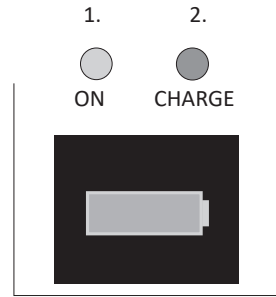

NOTE! Charging a deep discharged Li-ION battery

When charging a deep discharged Li-ION battery the charger will start charging at a low charging rate to protect the battery. During the low rate charging no indicator will light up.

When the low rate charging is completed the charger will automatically switch to normal charge rate and the "CHARGE" indicator will light up yellow and will turn off when charging is completed.

Charging with the control box internal charger (standard)

Plug the charger cable into mains (100-240 VAC), see charger information 1 - 2 above. The battery is fully charged after about 6 hours and the charger disconnects automatically, the yellow "CHARGE" diode turn of.

For maximum battery life, batteries must be charged regularly.

We recommend charging after each use or every night.

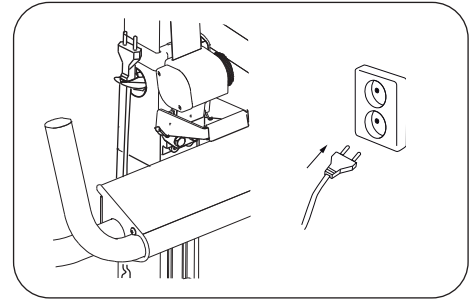

Never charge batteries in a wet area!

NOTE! If the charger cable is stretched out it should be replaced to avoid the risk of the cable getting caught and tear.

NOTE! The lift cannot be used when the charger cable is plugged into a wall socket.

NOTE! If the yellow "CHARGE" diode at the control box continuous to be lit after 8 hours, discontinue charging and replace the battery with a new one.

NOTE! A damaged battery shall be replaced and contact with leaking fluids shall be avoided.

Alternative charging procedures

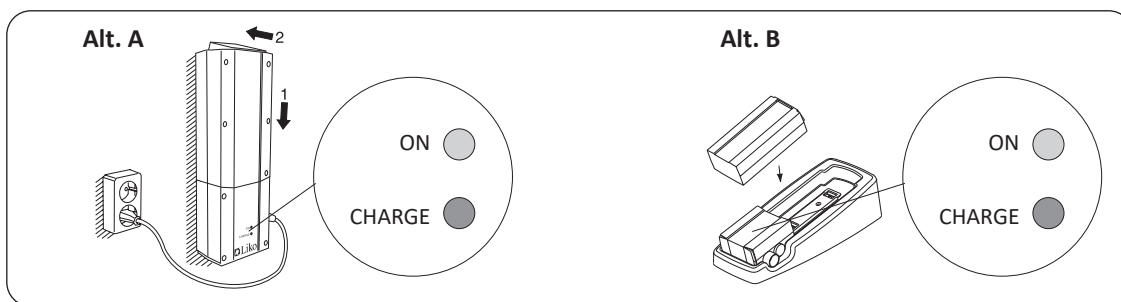

Wall mounted charger accessory or table charger housing accessory:

Loosen the holder for the charger cable. Remove the battery pack from the control box by loosening the locking device on top of the battery pack. See chapter "Assembly".

Charger information;

"ON" - lights up green when the charger is connected to mains.

"CHARGE" - lights up yellow constantly during charging and will turn off when charging is completed.

Alt. A. Place the battery pack on the wall mounted charger. Plug the charger cable into mains (100-240 VAC) check that both "ON" and "CHARGE" on the charger lights up.

Alt. B. Place the battery pack on the charger in the table charger housing. Plug the charger cable into mains (100-240 VAC) check that both "ON" and "CHARGE" on the charger lights up.

Maximum Load

Different maximum loads may apply to different products on the assembled lift unit, sling bar, sling and any other accessories used. For the assembled lift unit, including accessories, the maximum load is always the lowest maximum load rating for any of the components. A Golvo™ mobile lift that is approved for 200 kg (440 lbs) can be equipped with a lifting accessory that is approved for 300 kg (660 lbs). In this case, the maximum load of 200 kg (440 lbs.) applies to the assembled lift unit. Study the markings on the lift and lifting accessories or contact your Hill-Rom representative if you have any questions.

Recommended Lifting Accessories

⚠ Using lifting accessories other than those approved can entail a risk.

Generally recommended sling bars and accessories for Golvo mobile lifts are described below.

When changing a sling bar or other lifting accessories, the highest possible lifting height of the lift is affected. Before changing lifting accessories you should always ensure that the lift, after change, can fulfil the desired lifting height in order to manage the lifting situations for which the lift is to be used.

For additional guidance in selecting a sling, study the Instruction for use for the respective sling models. There you will also find guidance for combining Liko™ sling bars with Liko slings.

Contact your Hill-Rom representative for advice and information on Liko's product range.

*** this product is also available in a version with Quick-Release Hook.**

Universal SlingBar 350*

Max. 300 kg (660 lbs)

Prod. No. 3156074



Universal SlingBar 450*

(Standard on Golvo)

Max. 300 kg (660 lbs)

Prod. No. 3156075

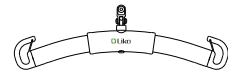

Universal SlingBar 600*

Max. 300 kg (660 lbs)

Prod. No. 3156076



Universal TwinBar 670 Twin*

Max. 300 kg (660 lbs)

Prod. No. 3156077

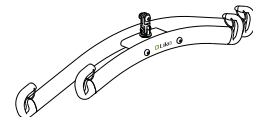

Universal SideBars 450 including bag

Max. 300 kg (660 lbs)

Prod. No. 3156079

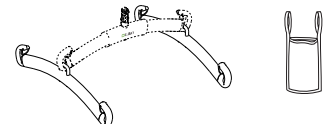

Sling Cross-bar 450*

Max. 300 kg (660 lbs)

Prod. No. 3156021

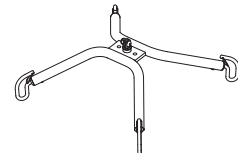

Sling Cross-bar 670*

Max. 300 kg (660 lbs)

Prod. No. 3156018

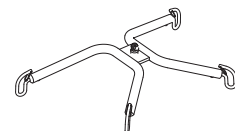

SlingBar Cover Paddy 30

(fits Universal SlingBars 350, 450, and 600, as well as SlingBar Slim 350)

Prod. No. 3607001



Bag for SlingBars

Prod. No. 2001025



Quick-Release Hook

Liko's Quick-Release Hooks are a system for quick change of lifting accessories on Liko's mobile and stationary lifts. The Golvo™ mobile lift must be equipped with Q-link in order to be used with the Quick-release Hook.

The Quick-Release Hook Universal fits the Universal Bars 350, 450 and 600 (prod. no. 3156074 - 3156076).

Quick-Release Hook TDM fits Sling Cross-bar 450 and 670 (prod. no. 3156021 and 3156018) and Universal TwinBar 670 (prod. no. 3156077).

Contact your Hill-Rom representative for more information.

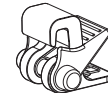

Quick-Release Hook Universal

Prod. No. 3156508



Quick-Release Hook TDM

Prod. No. 3156502



Q-link

Prod. No. 31590005

Stretchers

Golvo mobile lift can be used for horizontal lifting in combination with

Liko OctoStretch

Prod. No. 3156056

LikoStretch Mod 600 IC

Prod. No. 3156065B

FlexoStretch

Prod. No. 3156057

Contact your Hill-Rom representative for more information.

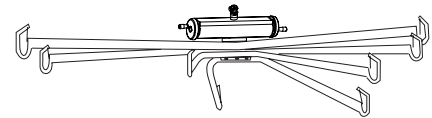

Prod. No. 3156056

LikoScale™ device

for weighing a patient in combination with Golvo mobile lift.

LikoScale™ 350, Max 400 kg (880 lbs)

Prod. No. 3156228

LikoScale™ 350 is certified according to the European Directive NAWI 2014/31/EU (Non-Automatic Weighing Instruments).

LikoScale™ devices only for use in the United states and Canada:

LikoScale™ 200, Max. 200 kg (440 lbs.)

Prod. No. 3156225

LikoScale™ 400, Max. 400 kg (880 lbs.)

Prod. No. 3156226

Contact your Hill-Rom representative for more information.

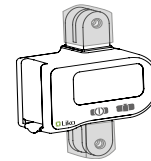

LikoScale 350

Prod. No. 3156228

Battery charger,

for wallmounting or to use with the Table charger housing

Prod. No. 2004106

Table charger housing

excl. charger and battery

Prod. No. 2107103

Battery

Lead battery (Pb)

Prod. No. 2006106

Battery

Li-ION battery

Prod. No. 2006110

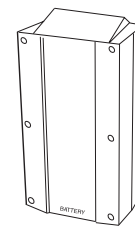
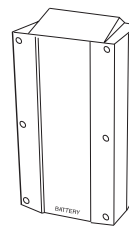
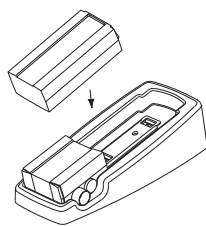
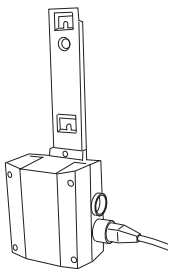

Leg Protector

Leg Protector (Golvo 9000), grey, pair

Prod. No. 2006012G

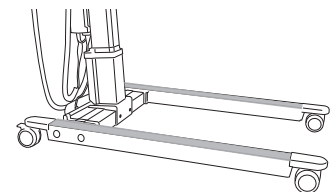

Holder for Quick Reference Guide

Prod. No. 2000100



Quick Guide

Liko Mobile lift system

(Fit's "Holder for Quick Reference Guide", Prod. No. 2000100)

Prod. No 2000400

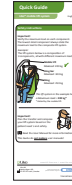

Recycling instructions



**Lead battery (Pb) or
Li-ION battery**



**Waste of Electrical and Electronic
Equipment (WEEE).**



Metals

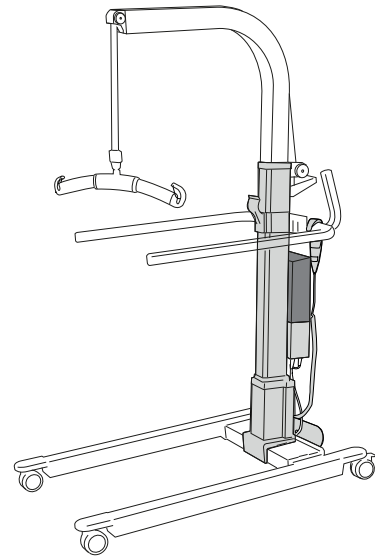

Old batteries are to be deposited at the nearest recycling station or given to personnel authorized by Hill-Rom.

Hillrom evaluates and provides guidance to its users on the safe handling and disposal of its devices to aid in the prevention of injury, including, but not limited to: cuts, punctures of the skin, abrasions, and any required cleaning and disinfection of the medical device after use and prior to its disposal. Customers should adhere to all federal, state, regional, and/or local laws and regulations as it pertains to the safe disposal of medical devices and accessories.

If in doubt, the user of the device shall first contact Hillrom Technical Support for guidance on safe disposal protocols.

Simple Troubleshooting

The lift cannot be operated with the hand control.



1. Check that the emergency stop button has not been pressed.
2. Check the battery capacity.
Check if the Li-ION battery has been set in to sleep mode, see chapter "Operation".
3. Check that the charger cable is not connected to an electric outlet.
4. Check that the hand control cable is correctly connected.
5. If the lift works via the operation panel, change the Hand Control.
6. *If the problem persists, please contact Hill-Rom.*

**The lift does not work up/down with the operation panel.
The base-width adjustment doesn't work (in/out) with the operation panel.**



1. Check that the emergency stop button has not been pressed.
2. Check that the cables to the control box are connected correctly.
3. Check that the charger cable is not connected to an electric outlet.
4. Check the battery capacity.
Check if the Li-ION battery has been set in to sleep mode, see chapter "Operation".
5. *If the problem persists, please contact Hill-Rom.*

The charger doesn't work.



1. Check that the charger cables are connected correctly.
2. Make sure that the battery is properly attached.
3. *If the problem persists, please contact Hill-Rom.*

The lift is stuck in the high position.



1. Check that the emergency stop button has not been pressed.
2. Check the battery capacity.
Check if the Li-ION battery has been set in to sleep mode, see chapter "Operation".
3. Check that the hand control cable is connected correctly.
4. Electrical emergency lowering, use the operation panel to lower the patient onto a firm surface.
5. Use the mechanical emergency lowering device to lower the patient onto a firm surface.
6. *If the problem persists, please contact Hill-Rom.*

The lift does not reach maximum lifting height.



1. Check that the lifting interval level is correctly set.
2. *If the problem persists, please contact Hill-Rom.*

If any noises are heard.



Contact Hill-Rom.

Cleaning and Disinfection

Safety recommendations

Cleaning and disinfecting procedures for Liko™ Mobile lifts. This instructions do not replace the facility's own cleaning and disinfection policies.

- Wear protective equipment according to manufacturer's instruction and per facility protocol throughout the cleaning operations, such as: rubber gloves, goggles, apron, face mask and shoe covers.
- Unplug mains (AC power source) before cleaning and disinfection.
- Never clean the lift by pouring water on it, steam cleaning it, or by using a high-pressure jet.
- Refer to the recommendations made by the cleaning and disinfecting product manufacturer.

Equipment:

- Protective equipment (such as: rubber gloves, goggles, apron, face mask and shoe covers) as recommended by the facility protocol and manufacturers instructions
- Clean buckets
- Cloths for washing and drying
- Soft brush
- Warm water
- To find Cleaning / Disinfectants compatible or not compatible for use on Liko's products, follow the "Application of commonly used Cleaning / Disinfectants on Liko products" in this document.

Cleaning instructions

1. ⚠️ **Unplug mains (AC power source) before cleaning and disinfection.**
2. Clean the lift with a cloth moistened with warm water and a neutral cleaning agent approved by your organization. A soft brush may be used to remove stains and resistant dirt.
3. Wipe down the entire lift starting from the top down. Do not use a cloth that is dripping wet. To have access to all areas run the lift into the highest and lowest positions and extend the base width adjustment entirely out. Remove the Battery to have access behind the battery. Lower the sling bar to get access to the whole lift strap. Fully extend the lift strap by using the emergency lowering. After cleaning the lift strap, and before you raise the sling bar, make sure the lift strap has dried. After the emergency lowering device is used, the lifting level needs to be restored; see "Operation" in this document.

4. Pay special attention to the following areas:

- Lift strap
- Sling bar (different designs)
- Armrest
- Mechanical emergency lowering
- Hand control
- Handles
- Control box
- Emergency stop
- Battery
- Wheels

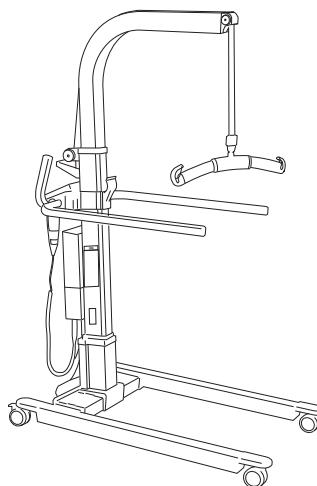

Disinfection Instructions

1. For the use of suitable disinfectants see "Application of commonly used Cleaning / Disinfectants on Liko products" in this document.
2. Use the choice of disinfectant according to the manufacturer's instructions and repeat the work step as in "Cleaning instructions".
3. Remove traces of disinfectant after disinfection. Wipe off the lift with a cloth moistened with clean water starting from the top and working down. The cloth shall not be so damp that it drips.

- ⚠️ **The lift may not be cleaned with CSI or equivalent.**
- ⚠️ **The hand control may not be cleaned with Viraguard or equivalent.**
- ⚠️ **The control box may not be cleaned with Anioxy Spray or equivalent.**
- ⚠️ **The lift strap may not be cleaned with Oxivir Tb, Dispatch, Chlor-Clean, Dismozon Pur or equivalent.**



Application of commonly used Cleaning / Disinfectants on Liko products

Chemical class	Active ingredient	pH	Cleaners / Disinfectant *	Manufacturer *)	May not be used on the following items:
Quaternary ammonium chloride	Didecyl dimethyl ammonium chloride = 8.704% Alkyl dimethyl benzyl ammonium chloride = 8.19%	9.0 – 10.0 in use	Virex II (256)	Johnson/Diversey	Foot rest for Sabina™ and Roll-On™
Quaternary ammonium chloride	Alkyl dimethyl benzyl ammonium chloride = 13.238% Alkyl dimethyl ethylbenzyl ammonium chloride = 13.238%	9.5 in use	HB Quat 25L	3M	
Accelerated Hydrogen Peroxide	Hydrogen Peroxide 0.1 -1.5% BenzylAlcohol: 1-5% Hydrogen Peroxide 0.1 -1.5% BenzylAlcohol: 1-5%	3	Oxivir Tb	Johnson/Diversey	The lift straps for Golvo™ and ceiling lifts
Phenolic	Ortho-Phenylphenol = 3.40% Ortho-Benzyl-para-Chlorophenol = 3.03	3.1 +/- 0.4 in use	Wexicide	Wexford Labs	
Bleach	Sodium hypochlorite	12.2	Dispatch	Caltech	The lift straps for Golvo™ and ceiling lifts
Alcohol	Isopropyl alcohol = 70%	5.0 – 7.0	Viraguard	Veridien	Hand controls for all lifts
Quaternary ammonium	n-Alkyl dimethyl benzyl ammonium chlorides = 0.105% n-Alkyl dimethyl ethylbenzyl ammonium chlorides = 0.105%	11.5 - 12.5	CSI	Central Solutions Inc.	Viking™, Liko M220™, Liko M230™, Uno™, Sabina™, Golvo™, LikoLight™, Roll-On™, LikoRall™, Multirall™
Benzyl-C12-18-alkyldimethylammonium, chlorides	Benzyl-C12-18-alkyldimethylammonium, chlorides (22 %) 2-Phenoxyethanol (20 %) Tridecylpolyethylenglycolether (15 %) Propan-2-ol (8 %)	approx 8.6 in use	Terralin Protect	Shülke	Foot rest for Sabina™ and Roll-On™
Organic peroxide (type E, solid)	Magnesium monoperoxyphthalate hexahydrate (50-100%) Anionic surfactant (5-10%) Nonionic surfactant (1-5%)	5.3 in use	Dismozon Pur	Bode	The lift straps for Golvo™ and ceiling lifts
Ethanol	Hydrogen peroxyde (2.5-10 %) Lauryldimethylamine oxid (0-2.5 %) Ethanol (2.5-10 %)	7	Anioxy-Spray WS	Anios	Control box for all mobile lifts
Trocirosene sodium	Adipic acid 10-30% Amorphous silica < 1% Sodium Toluene sulphionate 5-10 % Trocirosene sodium 10-30 %	4-6 in use	Chlor-Clean	Guest Medical Ltd	The lift straps for Golvo™ and ceiling lifts

*) Or equivalent

Inspection and Maintenance

For trouble-free use, certain details should be checked each day the lift is used:

- Inspect the lift and check to make sure that there is no external damage.
- Check the sling bar attachment.
- Check the lift strap for wear and to ensure the strap is not twisted.
- Check the functionality of the latches.
- Check the integrity of the lifting motion and the base-width adjustment.
- Check that the lifting interval level is set correctly and that the emergency lowering is working as it should (both the electrical and the mechanical).
- Charge the battery each day the lift is used and make sure the charger works.

When necessary, clean the lift with a moist cloth and check that the wheels are free from dirt. Find more detailed information regarding cleaning and disinfection of your Liko™ product in chapter; *Cleaning and Disinfection*.

⚠ The lift should not be exposed to running water.

Service

A periodic inspection of the lift should be carried out at least once per year.

⚠ Periodic inspection, repair and maintenance may be performed only in accordance with the Liko service manual by personnel authorized by Hill-Rom and using original Liko spare parts.

⚠ Service activities are not allowed with the patient in the lift.

Service Agreement

Hill-Rom offers the opportunity to enter into service contracts for the maintenance and regular inspection of your Liko product.

Expected Life Time

The product has an expected service life of 10 years when correctly handled, serviced and periodically inspected in accordance with Liko's instructions.

Parts listed below are subject to wear and tear and have specific expected life time:

- Handcontrol, expected life time 2 years,
- Battery, expected life time 3 years.

Transport and Storage

During transportation, or when the lift is not to be used for a long time, the emergency stop should be activated.

The environment where the lift is transported and stored should have a temperature of -10°C to +50°C (14°F to 122°F), 20-90% humid., pressure 700-1060 hPa.

The environment where batteries is transported and stored should have a temperature of -10°C to +40°C (14°F to 104°F) , 20-80% humid., pressure 700-1060 hPa.

Product Changes

Liko products undergo continuous development, which is why we reserve the right to make product changes without prior notice. Contact your Hill-Rom representative for advice and information about product upgrades.

Design and Quality by Liko in Sweden

The management system for both manufacturing and development of the product is certified in accordance with ISO9001 and its equivalent for the medical device industry, ISO13485. The management system is also certified in accordance with the environmental standard ISO14001.

Notice to Users and/or Patients in EU

Any serious incident that has occurred in relation to the device, should be reported to the manufacturer and the competent authority of the Member State in which the user and/or patient is established.



www.hillrom.com

 Liko AB
Nedre vägen 100
975 92 Luleå, Sweden
+46 (0)920 474700

Liko AB is a subsidiary of Hill-Rom Holdings Inc.

Enhancing outcomes for
patients and their caregivers:

